

## RITA-A

Asymmetric beam. Assembly with installation tape

### TECHNICAL SPECIFICATIONS:

Dimensions	36.0 x 28.4 mm
Height	17.3 mm
Fastening	tape, pin
Colour	white
Box size	
Box weight	4.3 kg
Quantity in Box	810 pcs
ROHS compliant	yes ⓘ



### MATERIAL SPECIFICATIONS:

Component	Type	Material	Colour
RITA-A	Reflector	HRPC	white
HEIDI-TAPE	Tape	Acrylic tape	black

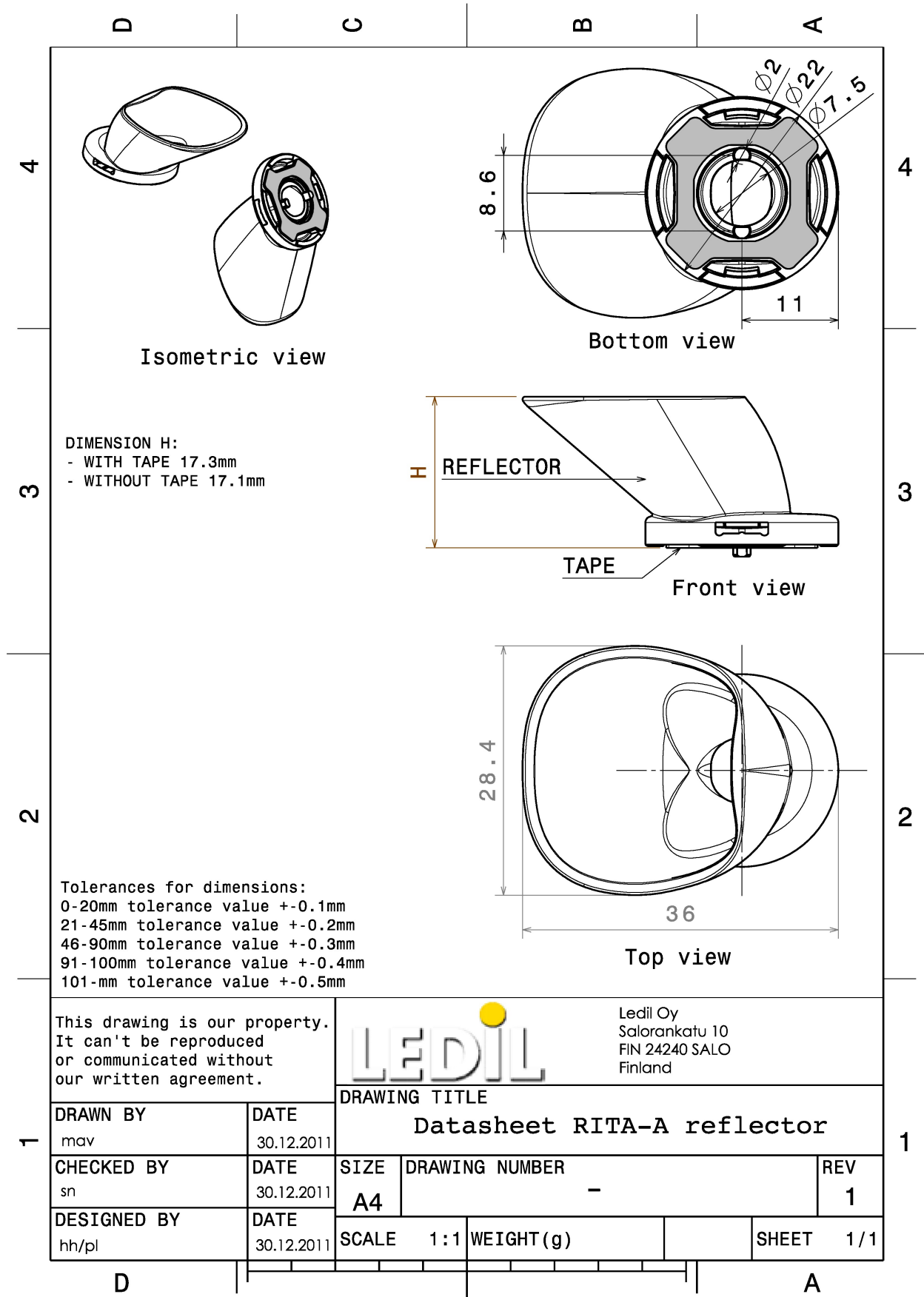

**PHOTOMETRIC DATA (MEASURED):**



LED XB-D  
FWHM Asymmetric  
Efficiency 84 %  
Peak intensity cd/lm  
Required components:

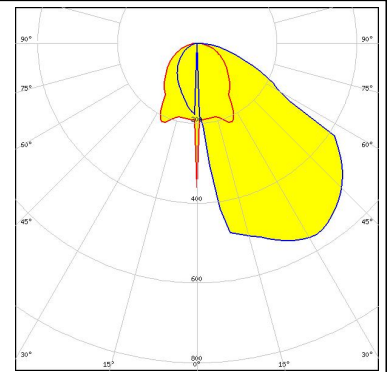

LED XM-L  
FWHM Asymmetric  
Efficiency 85 %  
Peak intensity 0.600 cd/lm  
Required components:

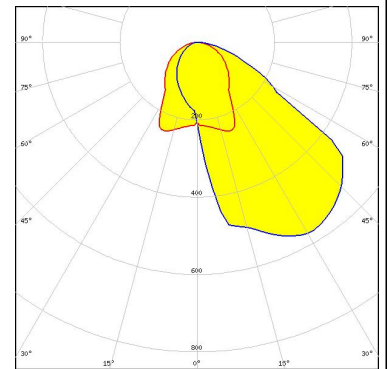
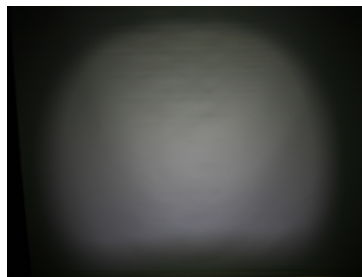

LED XM-L2  
FWHM Asymmetric  
Efficiency 86 %  
Peak intensity 0.600 cd/lm  
Required components:

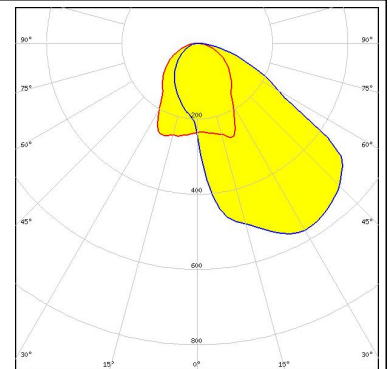
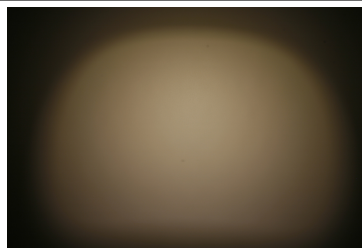

LED XP-G  
FWHM Asymmetric  
Efficiency 86 %  
Peak intensity cd/lm  
Required components:

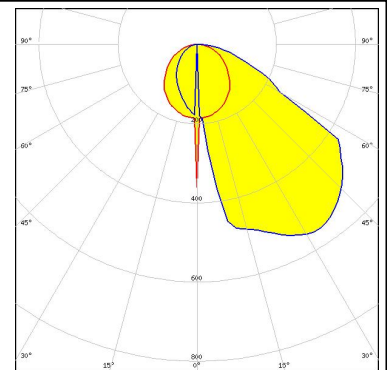

### PHOTOMETRIC DATA (MEASURED):



LED XP-G2  
 FWHM Asymmetric  
 Efficiency 87 %  
 Peak intensity 0.550 cd/lm  
 Required components:

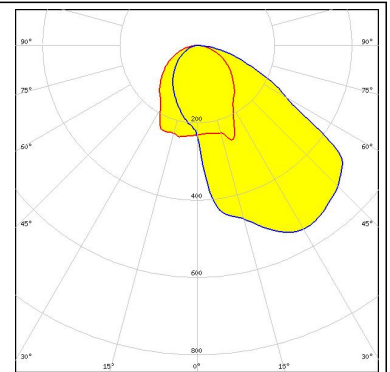
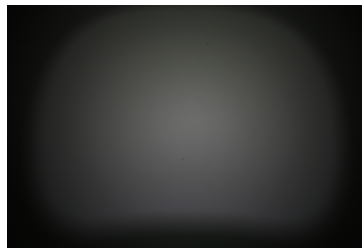

LED XT-E  
 FWHM Asymmetric  
 Efficiency 86 %  
 Peak intensity cd/lm  
 Required components:

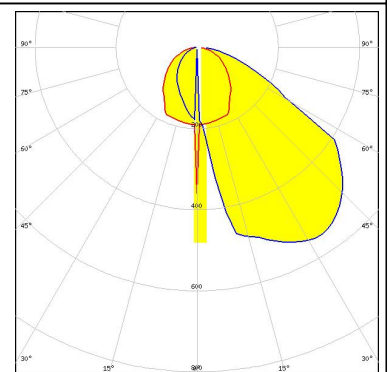

LED LUXEON A  
 FWHM Asymmetric  
 Efficiency 87 %  
 Peak intensity 0.600 cd/lm  
 Required components:

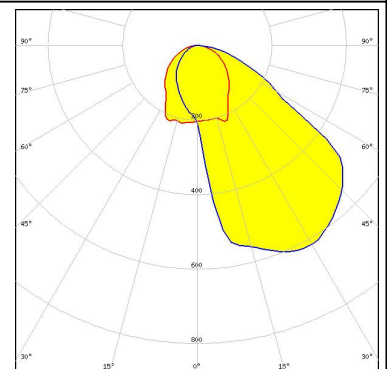

LED LUXEON Rebel  
 FWHM Asymmetric  
 Efficiency 87 %  
 Peak intensity 0.600 cd/lm  
 Required components:

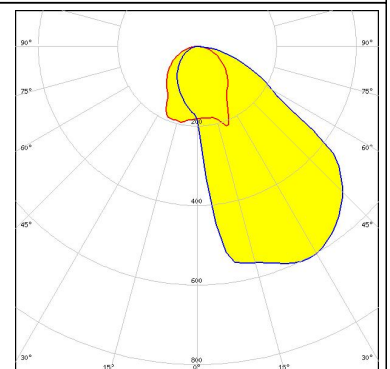

### PHOTOMETRIC DATA (MEASURED):

#### LUMILEDS

LED LUXEON Rebel ES  
 FWHM Asymmetric  
 Efficiency 85 %  
 Peak intensity cd/lm  
 Required components:

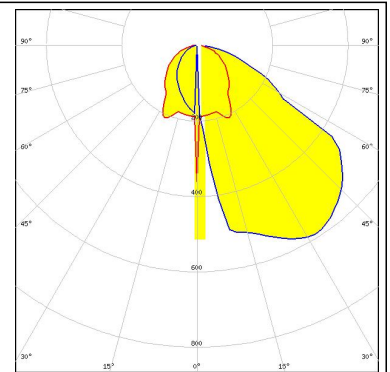

#### LUMILEDS

LED LUXEON T  
 FWHM Asymmetric  
 Efficiency 87 %  
 Peak intensity 0.600 cd/lm  
 Required components:

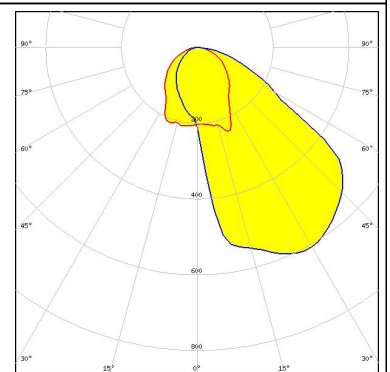
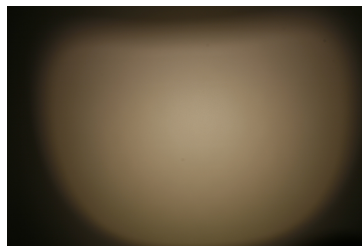

#### LUMILEDS

LED LUXEON TX  
 FWHM Asymmetric  
 Efficiency 87 %  
 Peak intensity 0.610 cd/lm  
 Required components:

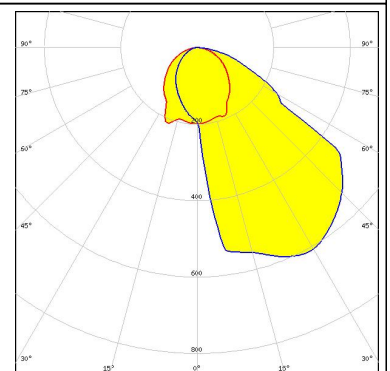
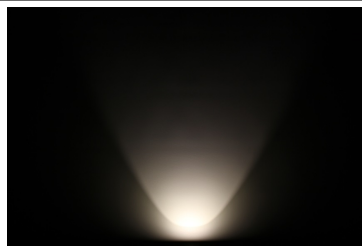

#### NICHIA

LED NCSxx19A  
 FWHM Asymmetric  
 Efficiency 86 %  
 Peak intensity 0.600 cd/lm  
 Required components:

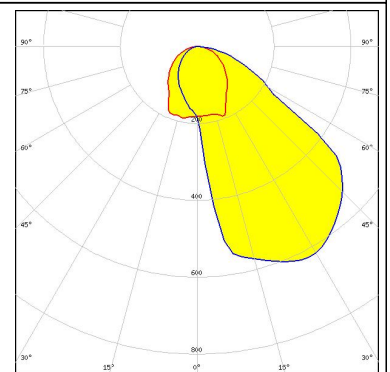
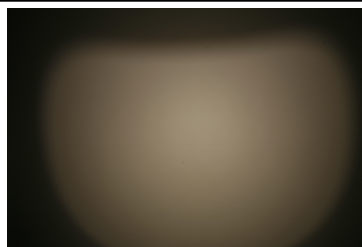

### PHOTOMETRIC DATA (MEASURED):



LED NS9x383  
 FWHM Asymmetric  
 Efficiency 87 %  
 Peak intensity 0.600 cd/lm  
 Required components:

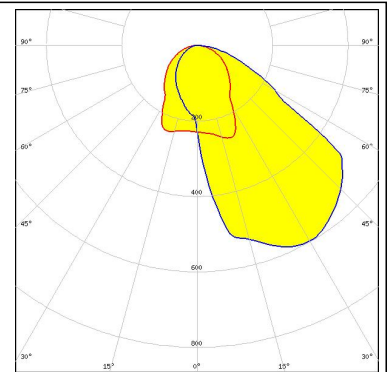

LED NVSxx19A  
 FWHM Asymmetric  
 Efficiency 86 %  
 Peak intensity 0.600 cd/lm  
 Required components:

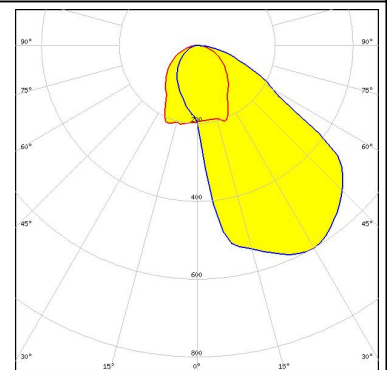

LED NVSxx19B/NVSxx19C  
 FWHM Asymmetric  
 Efficiency 86 %  
 Peak intensity 0.610 cd/lm  
 Required components:

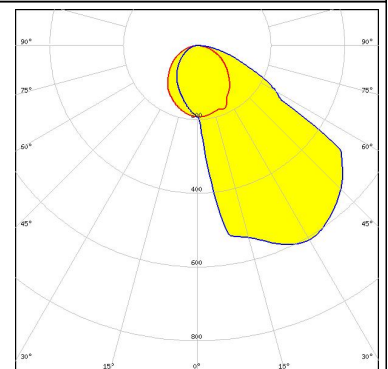

LED Oslon SSL 150  
 FWHM Asymmetric  
 Efficiency 86 %  
 Peak intensity 0.600 cd/lm  
 Required components:

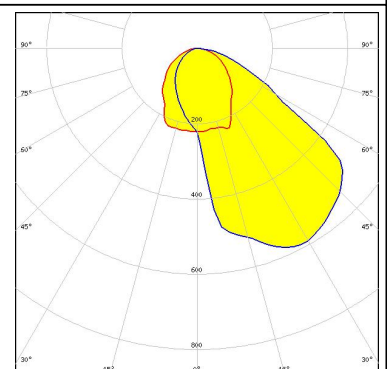

## PHOTOMETRIC DATA (MEASURED):

**OSRAM**  
Opto Semiconductors

LED            Oslon SSL 80  
FWHM        Asymmetric  
Efficiency    87 %  
Peak intensity 0.600 cd/lm  
Required components:

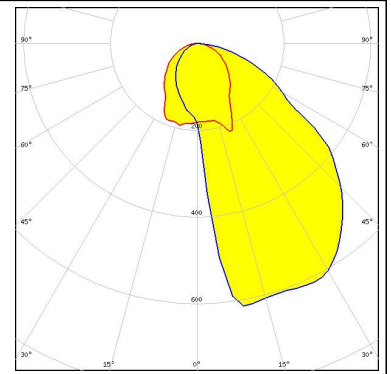
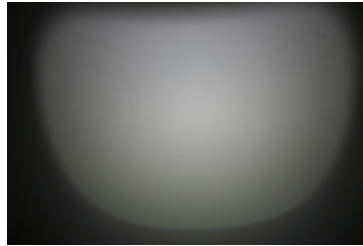



### GENERAL INFORMATION:

NOTE: The typical beam angle will be changed by different color, chip size and chip position tolerance. The typical total beam angle is the full angle measured where the luminous intensity is half of the peak value.

### MATERIALS:

As part of our continuous research and improvement processes, and to ensure the best possible quality and availability of our products, LEDiL reserves the right to change material grades without notice.

### PRODUCT DATA USER AGREEMENT AND DISCLAIMER:

The measured data in the provided downloadable LEDiL Product Datasheets and Mechanical 2D-Drawings is rounded and provided as reference for planning. LEDiL Oy's optical specifications have been verified by conducting performance testing of the products in accordance with the company's quality system. The reported data are averaged results of multiple measurements with typical variation. LEDiL Oy reserves the right to without prior notification make changes and improvements to its products.

LEDiL Oy assumes neither warranty, nor guarantee nor any other liability of any kind for the contents and correctness of the provided data. The provided data has been generated with highest diligence but the provided data may in reality not represent the complete possible variation range of all intrinsic parameters. Therefore, in certain cases a deviation from the provided data could occur.

LEDiL Oy reserves the right to undertake technical changes of its products without further notification which could lead to changes in the provided data. LEDiL Oy assumes no liability of any kind for the possible deviation from any provided data or any other damage resulting from the usage of the provided data.

The user agrees to this disclaimer and user agreement with the download or usage of the provided files.

#### LEDiL Oy

Joensuunkatu 13  
FI-24240 SALO  
Finland

#### LEDiL Inc.

228 West Page Street  
Suite D  
Sycamore IL 60178  
USA

#### Local sales and technical support

[www.ledil.com/  
where\\_to\\_buy](http://www.ledil.com/where_to_buy)

#### Shipping locations

Salo, Finland  
Hong Kong, China

#### Distribution Partners

[www.ledil.com/  
where\\_to\\_buy](http://www.ledil.com/where_to_buy)